

XTRU-4810

Topline Series | LED STEP LIGHTING

IMPACT
LIGHTING

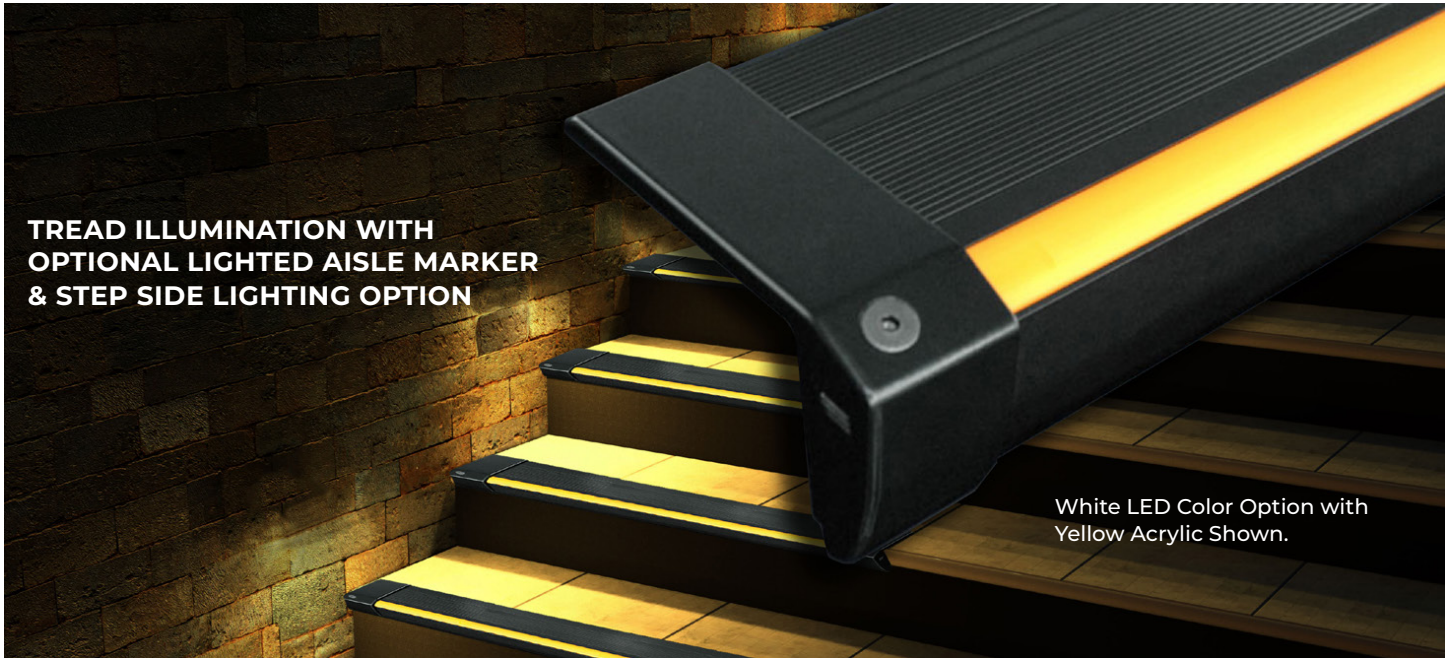

Impact Lighting's XTRU-4810 Topline Series Step Lighting is an aluminum stair profile with LED tread illumination with single or RGB color options. Perfect for theater applications this profile also offers optional lighted aisle marker with a number, letter or symbol. The profile comes in either black or aluminum finishes.

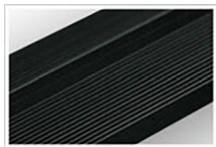

(black finish)

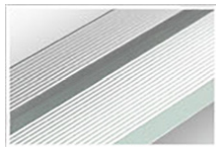

(aluminium finish)

XTRU-4810 Topline Series

Aluminum LED lighted stair profile with optional aisle marker and step side lighting.

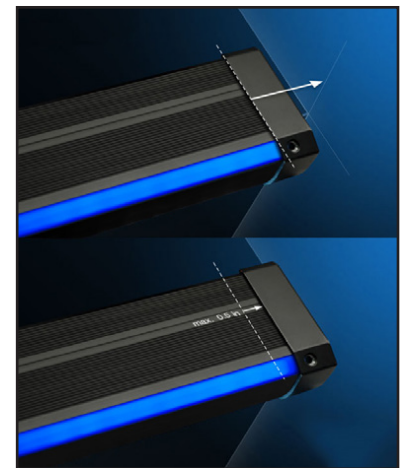

(Adjustable Endcaps up to 1.5mm/1/2")



(optional aisle marker)



(optional step side lighting)

KEY FEATURES:

- Fix finished edge of step with screws or an adhesive
- Can be installed on carpeted steps
- Anti-Slip Surface
- Adjustable end caps
- No visible LED points
- Optional lighted number, letter or symbol aisle marker
- NEW Step side lighting option
- Custom cut to length (max 2 meters / 78 inches)
- Profile allows running of wires without surface milling

IMPACT LIGHTING

2814 Silver Star RD., Suite B, Orlando, Florida 32808 USA • Ph. 1.800.507.5714 • Email: sales@impactlightinginc.com

www.impactlightinginc.com



PROJECT	DATE
TYPE	QTY.

LED STEP LIGHTING WITH SIDE LIGHTING OPTION



XTRU-4810
Topline Series

Aluminum LED lighted stair profile with optional aisle marking.
(yellow tread cover with white LED shown)

Impact Lighting's XTRU-4810 Topline Series Step Lighting is an aluminum stair profile with LED tread illumination with single or RGB color options. Perfect for theater applications this profile offers an optional lighted aisle marker with number, letter or symbol. The profile comes in black or aluminum finishes.

KEY FEATURES

- Fix finished edge of step with screws or an adhesive
- Can be installed on carpeted steps
- Anti-Slip Surface
- Adjustable end caps
- No visible LED points
- Optional lighted number, letter or symbol aisle marker.
- Custom cut to Length (max 2 meters / 78 inches)
- Profile allows running of wires without surface milling

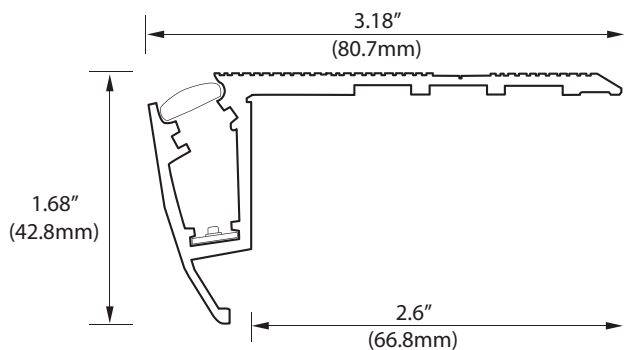

SIDE VIEW

TREAD COVER COLOR

	BLUE
	RED
	YELLOW
	CLEAR
	MILKY

ORDERING Example: XTRU-4810-24"-BLK-BL-WH-L-B = XTRU-4810 Profile 24", black finish, blue tread cover, white tread LED, left endcap, letter B marker

MODEL	CUT LENGTH	HOUSING FINISH	TREAD COVER COLOR *	TREAD LED COLOR	ENDCAPS	OPTIONAL MARKER
XTRU-4810	<input type="text"/>	<input type="text"/>	<input type="text"/>	<input type="text"/>	<input type="text"/>	<input type="text"/>
Aluminum LED Lighted Stair Profile	Write desired length above (0.15M - 2M) (6" - 78.5")	AL - Aluminum Finish BLK - Black Finish	BL - Blue Acrylic RED - Red Acrylic YE - Yellow Acrylic CL - Clear Acrylic MK - Milky White Acrylic	WH - White RGB - Red Green Blue * *requires controller	L - Left Endcap R - Right Endcap B - Left and Right Endcaps C - Corner Caps (allow for side and face extrusions to connect seamlessly without mitering)	N - NONE "_____" - Write number, letter or symbol above

* When choosing a colored acrylic riser White LED is suggested



PROJECT	DATE
TYPE	QTY.

LED STEP SIDE LIGHTING



Impact Lighting's XTRU-4810-SL Series Side Step Lighting is an additional compliment to the XTRU-4810 aluminum step profiles. LED step side illumination adds that extra safety and wow factor with single or RGB color options. Perfect for theater applications, these side profiles offers a cross line cable management system that overrides wiring obstacles.

KEY FEATURES

- Fix finished edge of step with screws or an adhesive
- Can be installed on carpeted steps
- Adjustable end caps
- No visible LED points
- Custom cut to Length (max 2 meters / 78 inches)
- Profile allows running of wires without surface milling

XTRU-4810 (topline series) **XTRU-4810-SL (sideline series)**

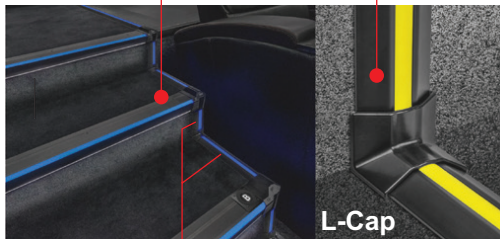

TREAD COVER COLOR

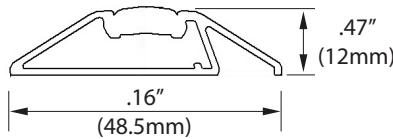
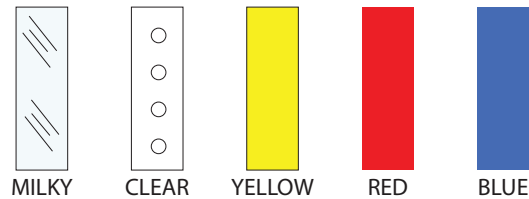

SIDELINE COVER

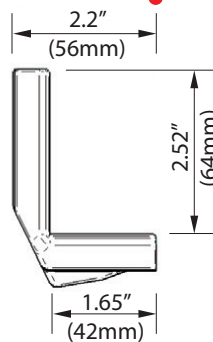

SIDELINE TRI-CAP

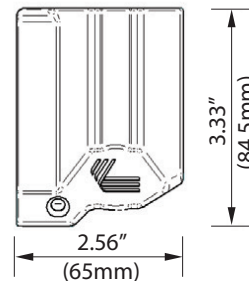

SIDELINE L-CAPS

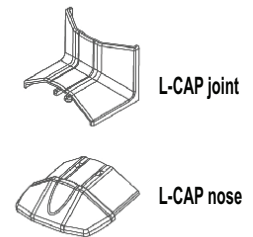

ORDERING Example: XTRU-4810-2-12"/2-7" - BLK-BL-WH-TCR-LCN = XTRU-4810-SL Profile, 2-12" and 2-7" side profiles with, black finish, blue tread cover, White Tread LED, Tri-i endcap-right-Lcap-nose

MODEL	CUT LENGTHS	HOUSING FINISH	TREAD COVER COLOR *	TREAD LED COLOR	Tri-CAPS	L-CAPS
XTRU-4810-SL Aluminum LED Lighted Side Stair Profile	Write desired cut lengths above (0.15M - 2M) (6" - 78.5") eg: 2 - 12" / 2 - 7"	AL - Aluminum Finish BLK - Black Finish	BL - Blue Acrylic RED - Red Acrylic YE - Yellow Acrylic CL - Clear Acrylic MK - Milky White Acrylic	WH - White RGB - Red Green Blue * *requires controller	TCR - Tri-Cap Right TCL - Tri-Cap Left LRTC - Left & Right Tri-Caps	LCJ - L-Cap joint LCN - L-Cap-nose

* When choosing a colored acrylic riser White LED is suggested

